

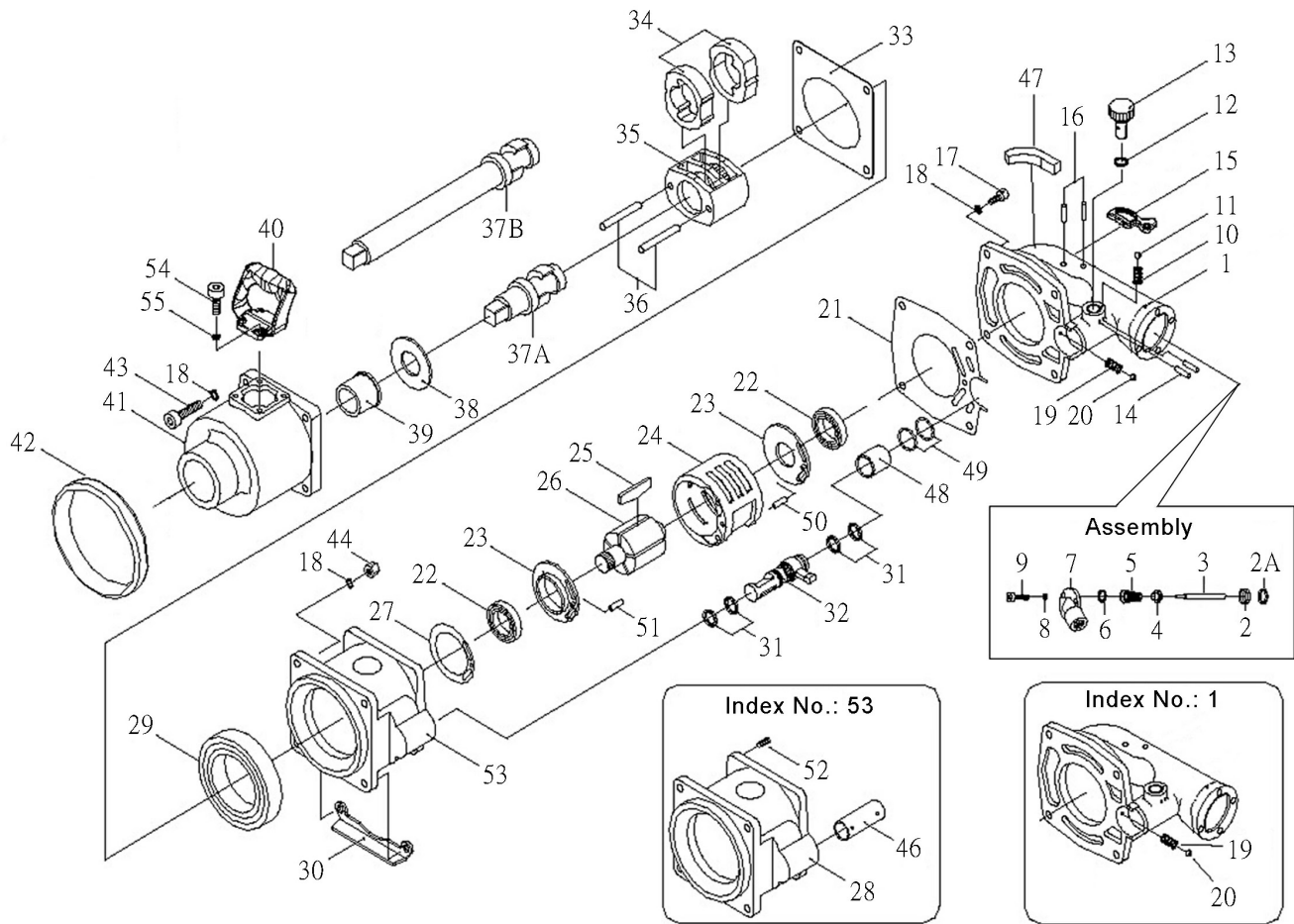

1-1/2" Drive Ultra Duty Air Impact Wrench



Parts List : 9K3390, 9K3398

2013.01

No.	Parts No.	Description	Q'ty	No.	Parts No.	Description	Q'ty	No.	Parts No.	Description	Q'ty
★ 1	08K301	Trigger Handle Assembly {incl.19.20}	1	● 20	08K320	Steel Ball	1	41	09K341	Hammer Case	1
2	08K302	Throttle Valve Seat	1	21	08K321	Gasket	1	42	08K342	Shield Housing Nose	1
2A	08K302A	Throttle Valve Washer	1	● 22	08K322	Ball Bearing	2	★ 43	08K343	Screw Assembly {incl.18(6)}	4
3	08K303	Throttle Valve Plunger	1	★ 23	08K323	Rear and Front End Plate Assembly {incl.22}	2	44	08K344	Lock Nut	4
4	08K304	Throttle Valve	1	24	08K324	Cylinder	1	● 46	08K346	Reverse Valve Bushing	1
5	08K305	Spring	1	25	08K325	Rotor Blade	7	47	08K347	Rubber Cap	1
6	08K306	O-Ring	1	26	08K326	Rotor	1	48	08K348	Bushing	1
7	08K307	Hose Fitting	1	27	08K327	Gasket	1	49	08K349	O-Ring	2
● 8	08K308	Spring Washer	4	● 28	08K328	Motor Housing	1	50	08K350	Spring Pin	1
★ 9	08K309	Screw Assembly {incl.8}	4	29	08K329	Ball Bearing	1	51	08K351	Spring Pin	1
10	08K310	Spring	1	30	08K330	Motor Housing Protector	1	● 52	08K352	Heli Coil	4
11	08K311	Steel Ball	1	31	08K331	O-Ring	4	★ 53	08K353	Housing Assembly {incl.28.46.52}	1
12	08K312	O-Ring	1	32	08K332	Reverse Valve	1	★ 54	08K354	Screw Assembly {incl.55}	4
13	08K313	Air Regulator	1	33	08K333	Gasket	1	● 55	08K355	Spring Washer	4
14	08K314	Spring Pin	2	34	08K334	Hammer	2	TK	08K3TK	Tune-Up Kit (Includes Illustrated) 5.6.10.11.12.19.20.21.22.25.27.29.31.33.49	1 Set
15	08K315	Inside Trigger	1	35	08K335	Hammer Frame	1				
16	08K316	Spring Pin	2	36	08K336	Hammer Pin	2				
★ 17	08K317	Screw Assembly {incl.18(4)}	4	37A	09K337A	Standard Anvil (for 9K3390)	1				
● 18	08K318	Spring Washer	10	37B	09K337B	8" Ext. Anvil (for 9K3398)	1				
● 19	08K319	Spring	1	38	09K338	Washer	1				
				39	09K339	Bushing	1				
				40	08K340	Side Spade Handle	1				

★ Must be Purchased in Assembly Set

● Cannot be Sold Separately due to Assembly Difficulty